

# SOMMERKAMP<sup>®</sup>

CITIZENS BAND  
TRANSCEIVER

5 WATT 32 CHANNEL

---

INSTRUCTION MANUAL



MODEL TS-732

## CONTROL LOCATIONS:

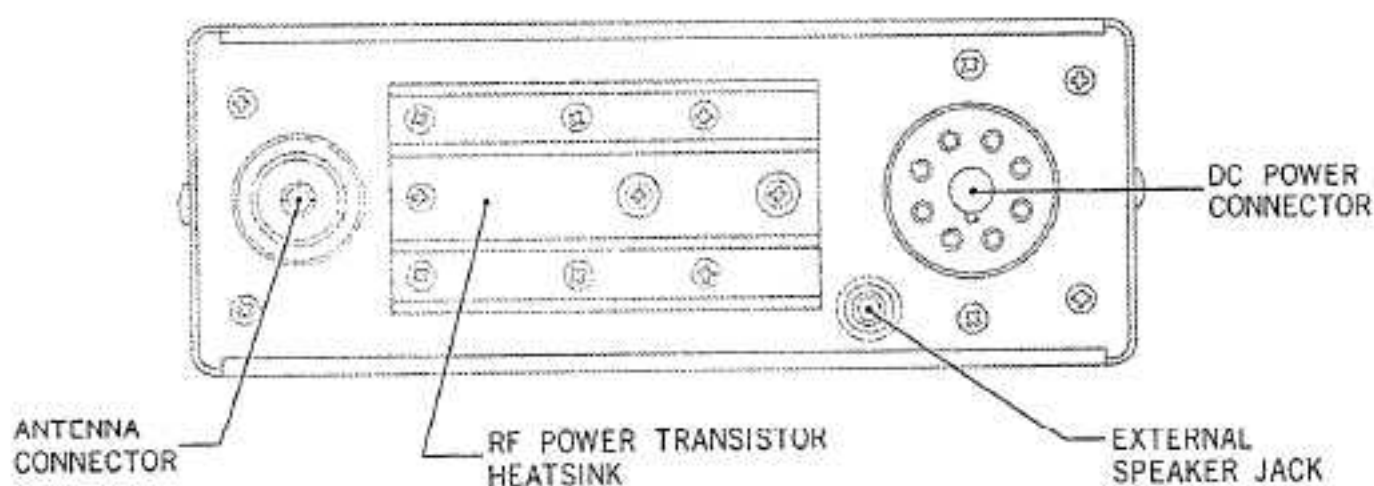
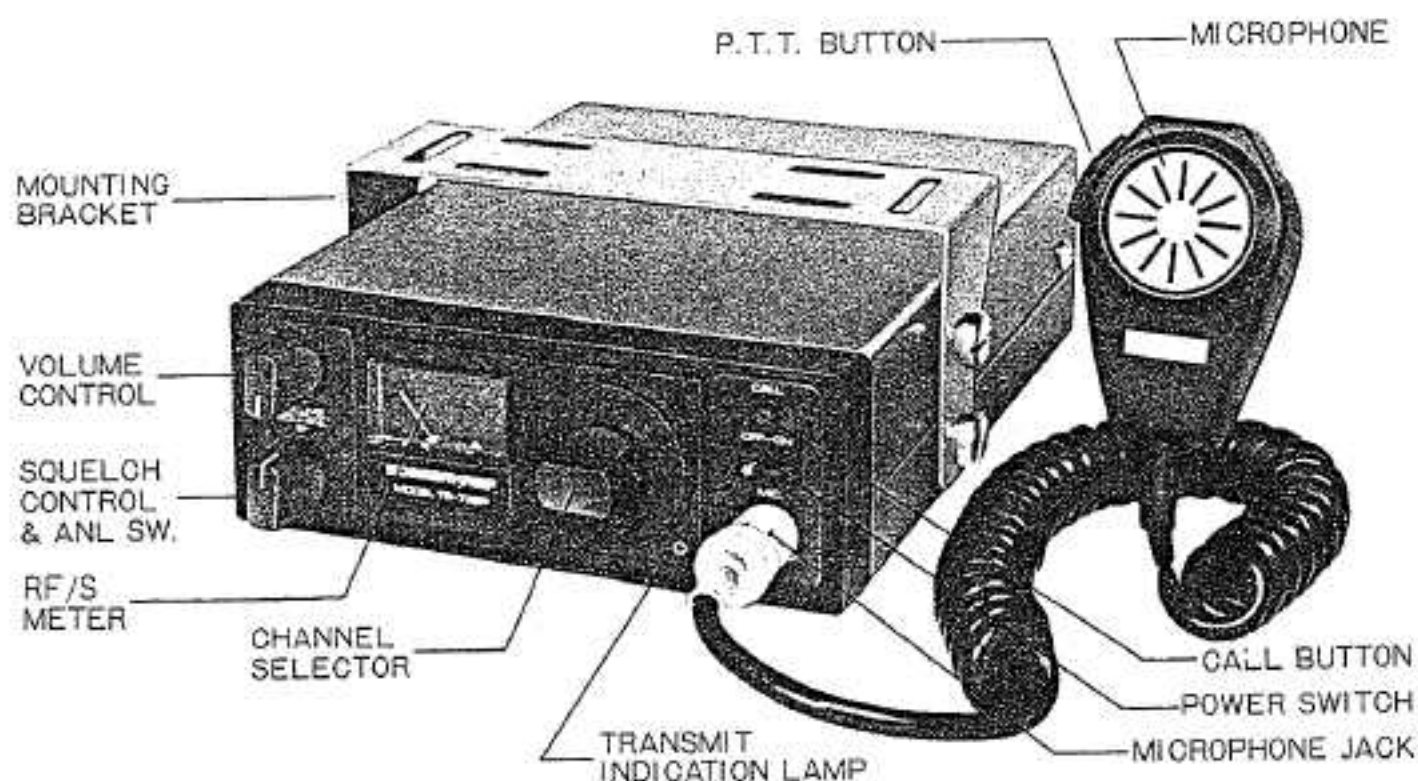

## PACKING LIST:

Beside this manual, the carton shall contain the following items:

- 1 Transceiver TS-732
- 1 Mounting bracket
- 4 Screw for Mounting bracket
- 1 Microphon hanger
- 1 DC cord with Fuse holder and 8 pin connector
- 1 Microphone

## GENERAL DESCRIPTION

Your SOMMERKAMP TS-732 transceiver has been designed for continuous heavy duty mobile and base station application. It can be operated with a microphone and internal speaker or headset, speaker/microphone combination, telephoneset incorporating automatic voice operated transmit/receive switching, external selective calling with automatic answerback and many more.

### GENERAL:

The transceiver is designed to operate from either 110/220 Volt AC or 12 Volt DC powersupply as a base or mobile station. Its straight forward 32 channel capability allows it to operate on any combination of frequencies within 26.5 and 29.7 MHz by inserting the corresponding xtals and retuning the transceiver if required. The Xtals in the transceiver are standard 27 MHz CB Xtals with plus or minus 455 KHz receiver offset. No special synthesiser or IF Xtals are required.

### RECEIVER SECTION

The receiver section is designed to receive amplitude modulated (AM/A3) signals in the 26.965 to 27.275 MHz. (11 meter) citizens band. The unique combination of low noise Field Effect Transistors (FET), single conversion, a combination of mechanical ceramic, and L/C filters, fully automatic noise limiter and a hifi quality speaker amplifier will give you exceptional reception quality in this fine piece of equipment.

In addition, the above combination of the latest technology provides you with a sensitivity and unwanted signal rejection and noise suppression available previously only in space and military communication equipment.

The power supply of the receiver RF, IF and oscillator section is stabilized by an extreme sharp cut-off Zener diode to obtain the high sensitivity and unwanted signal rejection. The fully automatic series gate noise limiter, which virtually cuts off the audio output during ignition noise pulses, is defeatable to make even the weakest signal audible which otherwise would be cut off by the threshold level of the ANL switching diode.

The high squelch sensitivity is achieved by using a separate squelch detector and switching circuit with a carefully balanced hysteresis. The transformerless hifi quality audio power amplifier will drive any load between 8 ohms and indefinite such as internal speaker or external speaker/microphone or headset combinations having the above impedances.

The meter indicates the field strength during reception of a signal.

## TRANSMITTER & MODULATOR SECTION:

The transmitter section is designed for continuous heavy duty transmission of amplitude modulated (AM/A3) signals in the 26.965 to 27.275 MHz. (11 meter) citizens band.

The transmitter consists of crystal controlled oscillator. The output of this oscillator is amplified in a class A buffer followed by a tuned filter, and a highly efficient collector-modulated class C driver and power output stage, coupled by series and pi-matching filters to the antenna jack.

The modulator consists of an input audio filter, integrated pre-and power amplifier and modulation transformer. This gives you the lowest possible modulation distortion and up to 100% modulation. The input is designed for 500 to 10K ohm dynamic microphone or 8 ohm speaker/microphone combination with a 1K ohm resistor in series.

## RECEIVE/TRANSMIT SWITCHING:

The receive/transmit switching is done by a single pole, single throw switch in the microphone and a combination of NPN and PNP switching transistors.

## METER:

The combination meter provides you with the following functions:

During receive mode.....it indicates the incoming signal strength.

During transmit mode...it indicates the output power.

## AC POWERSUPPLY

The AC powersupply consists of the heavy duty power transformer, a 4 diode full wave bridge rectifiers and a heavy duty voltage stabiliser for 13.5 Volt for the receiver and transmitter sections.

## DC POWERSUPPLY

This transceiver is designed to operate only from a 12V.DC negative grounded powersupply.

## BASE STATION INSTALLATION AND CHECKOUT

Unpack the transceiver carefully and check for exterior damages and the accessories.

Connect the 3 wire AC cord to an AC plug in the following manner:

1. blue to AC terminal
2. brown to AC terminal
3. yellow/green to the earth terminal

Connect the antenna plug to the antenna jack with an SWR-Meter inserted into the antenna cable.

Connect the microphone to the microphone jack.

Place the transceiver in operating position and connect the AC plug to a 220 Volt 50 Hz AC output.

Check very carefully that nothing touches the backpanel and that there is a min. 10 cm space between the backpanel and any object nearby because the transmitting transistors will heat up to 100 degree Centigrade and carry a voltage of 14 Volt DC and high power RF.

Switch the transceiver ON.

The receiving, meter and the channel lamp shall light up.

Turn the Squelch control to min. (ANL OFF)

Turn the Volume control to max. until you hear a rushing sound from the speaker.

Switch the channelselector to CH 1.

Push the transmit button on the microphone and check with the SWR-Meter immediately the SWR of your antenna. The SWR must be less than 1 to 2. Do this within 3 seconds, because if the SWR is higher than 1 to 2 it is very likely that the transmitting transistors will be damaged if you operate the transmitter too long with a antenna having a too high SWR. Also read carefully the recommendations on antennas.

If the SWR is less than 1 to 2 continue installation. If it is more than 1 to 2 repair or replace your antenna.

Check that the meter needle is near the red mark during transmitting.

Talk into the microphone. The meter needle shall move a little.

Release the transmit button and switch the channelselector to channel 1, 2 ectr, until you receive a station.

Wait until this station stops to transmit and turn the Squelch control slowly to max. until the background noise just disappears. When the station starts to transmit again, you will hear this station, but you will not hear the background noise during non transmitting periods.

## MOBILE INSTALLATION

Mounting bracket and screws are supplied for mounting the transceiver underneath the dashboard. Microphone hanger and screws are also supplied.

For electrical connection, first make sure that the transceiver is turned off. Connect the red wire to the ACC terminal of the ignition switch or + terminal of battery and ground the red and white or black wire to the chassis of the vehicle. The black wire should be grounded as short as possible to minimize noise interference.

This transceiver is designed for use with the negative ground system.

## OPERATING INSTRUCTIONS

The transceiver is ready to operate when it is installed with an antenna properly connected. Note that the communication range differs depending upon the environment where the transceiver is operated. You may reach 30 or 40 kilometers where no obstacle exists, but the range may be limited to 5 or 6 kilometers in cities where many high buildings disturb the communication.

- 1) Turn the set on by switching the ON-OFF snap switch to ON and the channel dial will be lighted. Turn the volume control clockwise to increase the audio sound. Note that the volume control knob is only for adjusting the audio volume, not to increase the transmitting power.
- 2) Turn the squelch control clockwise until incoming noise is eliminated. Do not turn it excessively as the sensitivity may be reduced.
- 3) Turn the squelch control counter-clockwise to switch off the ANL (Automatic Noise Limiter)
- 4) Turn the channel selector knob to the desired channel.
- 5) For transmitting, press the button on the microphone and speak into it normally. Release the button for receiving.

## METER

The meter reading indicates the signal strength at receiving, and functions as an output indicator at transmitting, and the meter pointer should be within the Red zone under the normal conditions.

# SCHEMATIC DIAGRAM

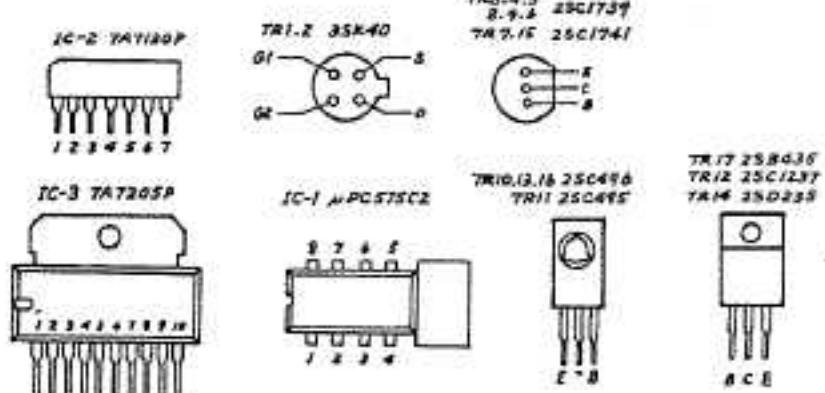
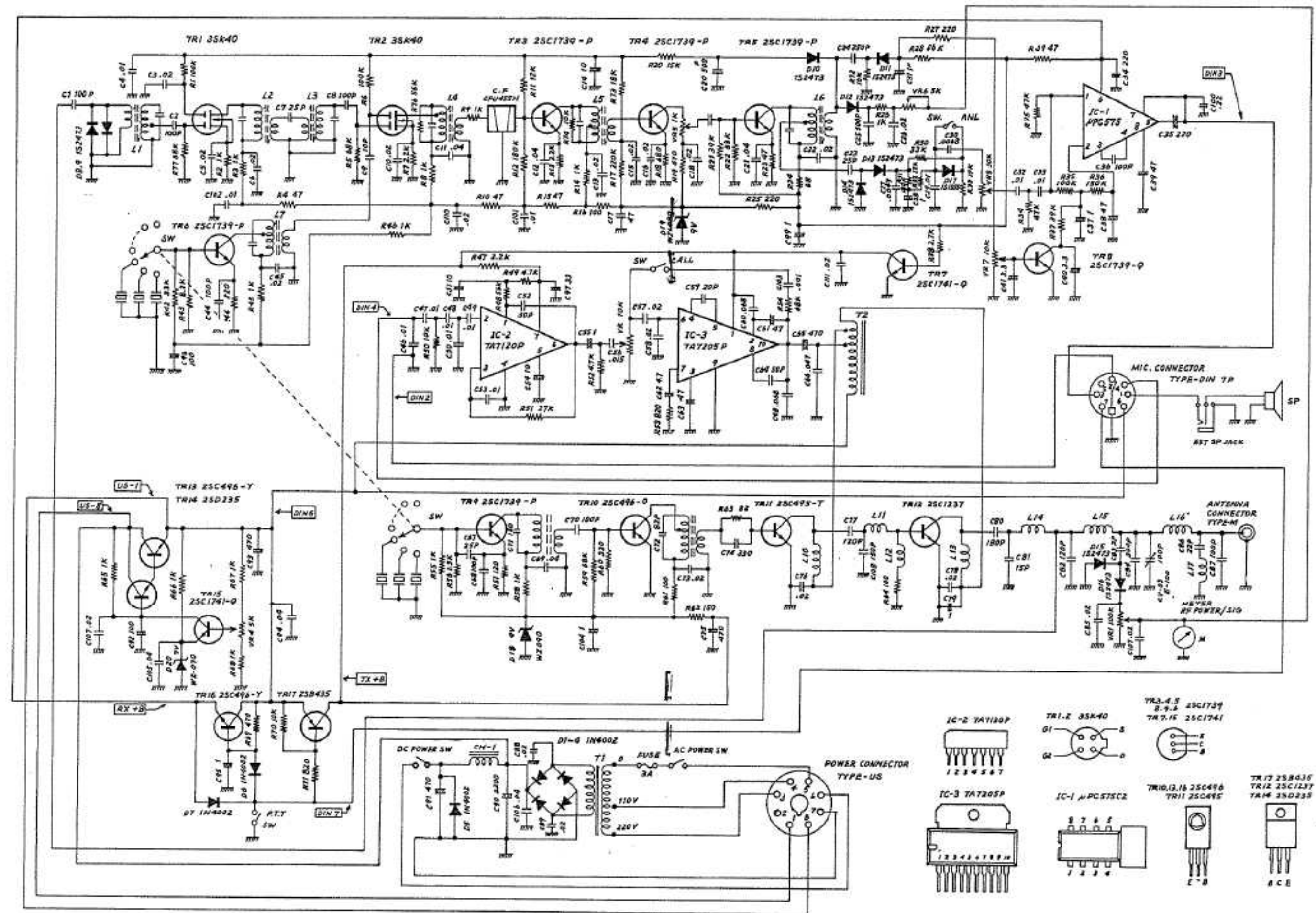

## MICROPHONE JACK

The 7-pin DIN standard accessory jack has the following internal connections:

1. Microphone input (Z 600-10K ohm)
2. Transmit/Receive switching.
3. Internal microphone output (Z 1K ohm)
4. Internal speaker (Z 8 ohm)
5. Audio output (Z 8 ohm-10K ohm)
6. +12V for VOX unit etc.
7. Ground return for 1-6.

Always operate the transceiver with the microphone plug inserted in the microphone jack, or with the following external connections:

### 1. Microphone with VOX.

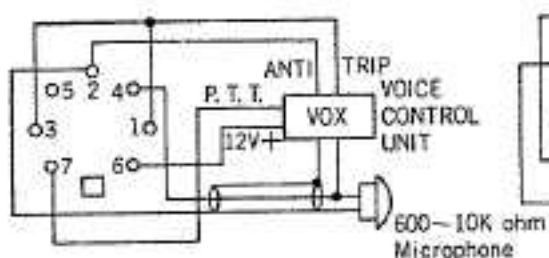

### 2. Headset or Telephoneset with PTT.

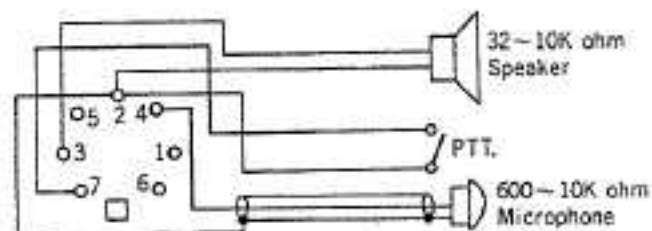

### 3. External microphone

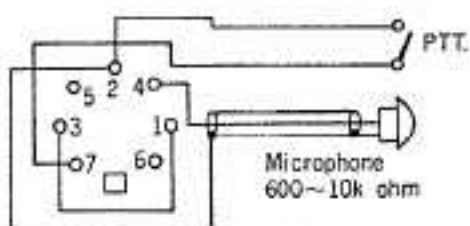

### 4. Headset or Telephoneset with VOX

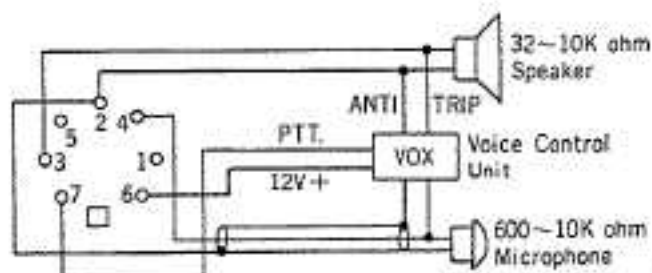

### 5. External microphone/speaker with PTT.

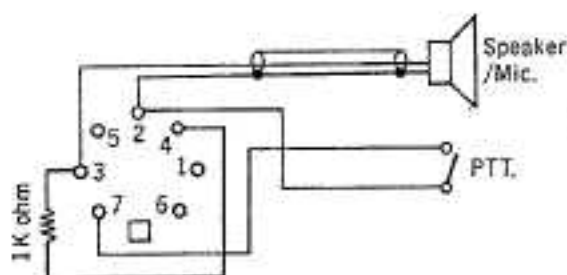

### 6. Internal connection

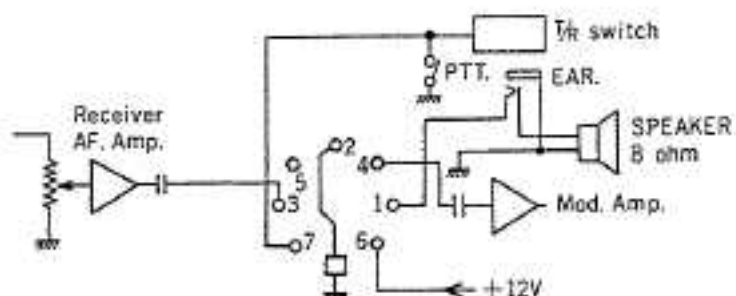



# MAIN PARTS LAYOUT

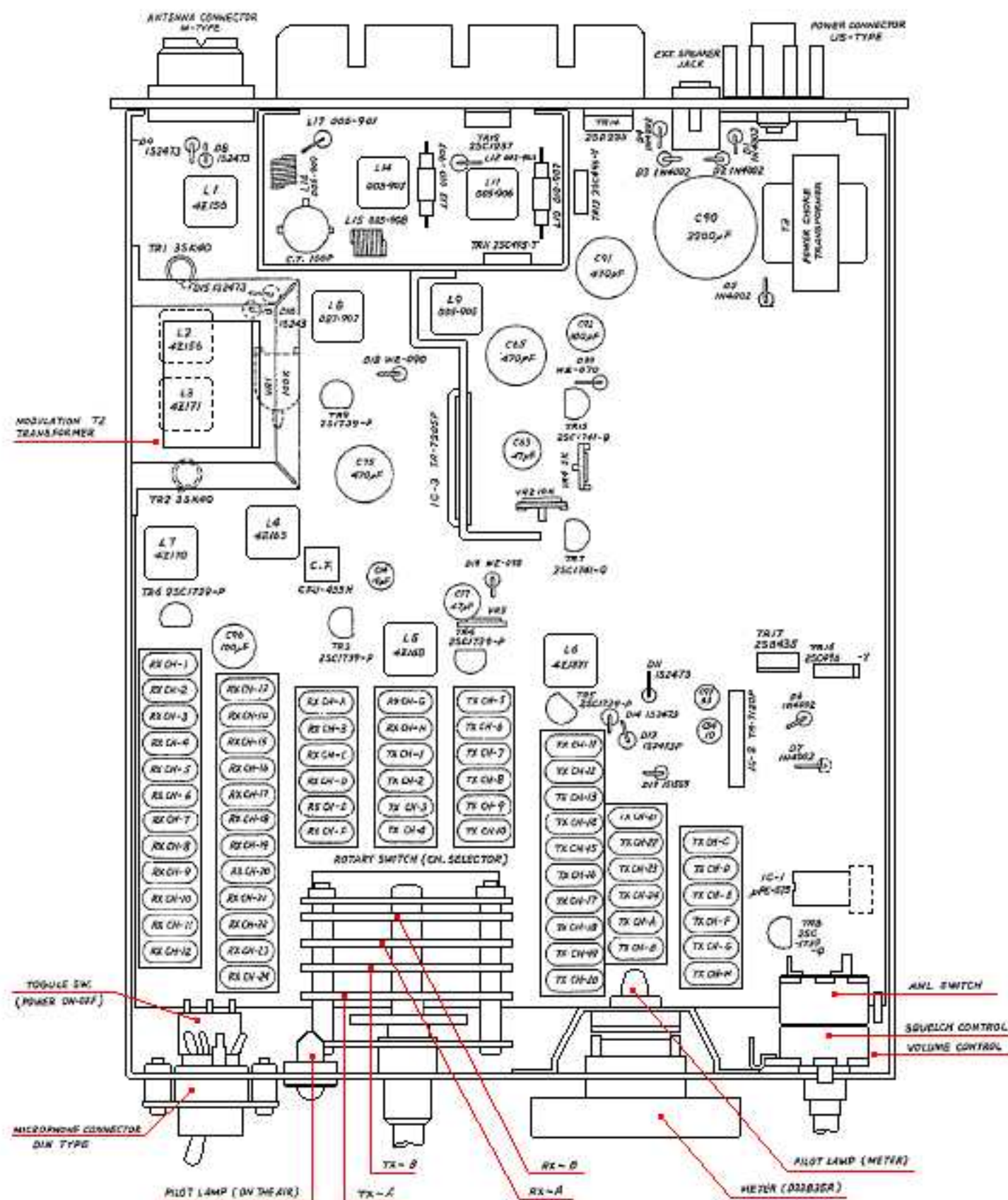

# PRINTED CIRCUIT BOARD PARTS LAYOUT

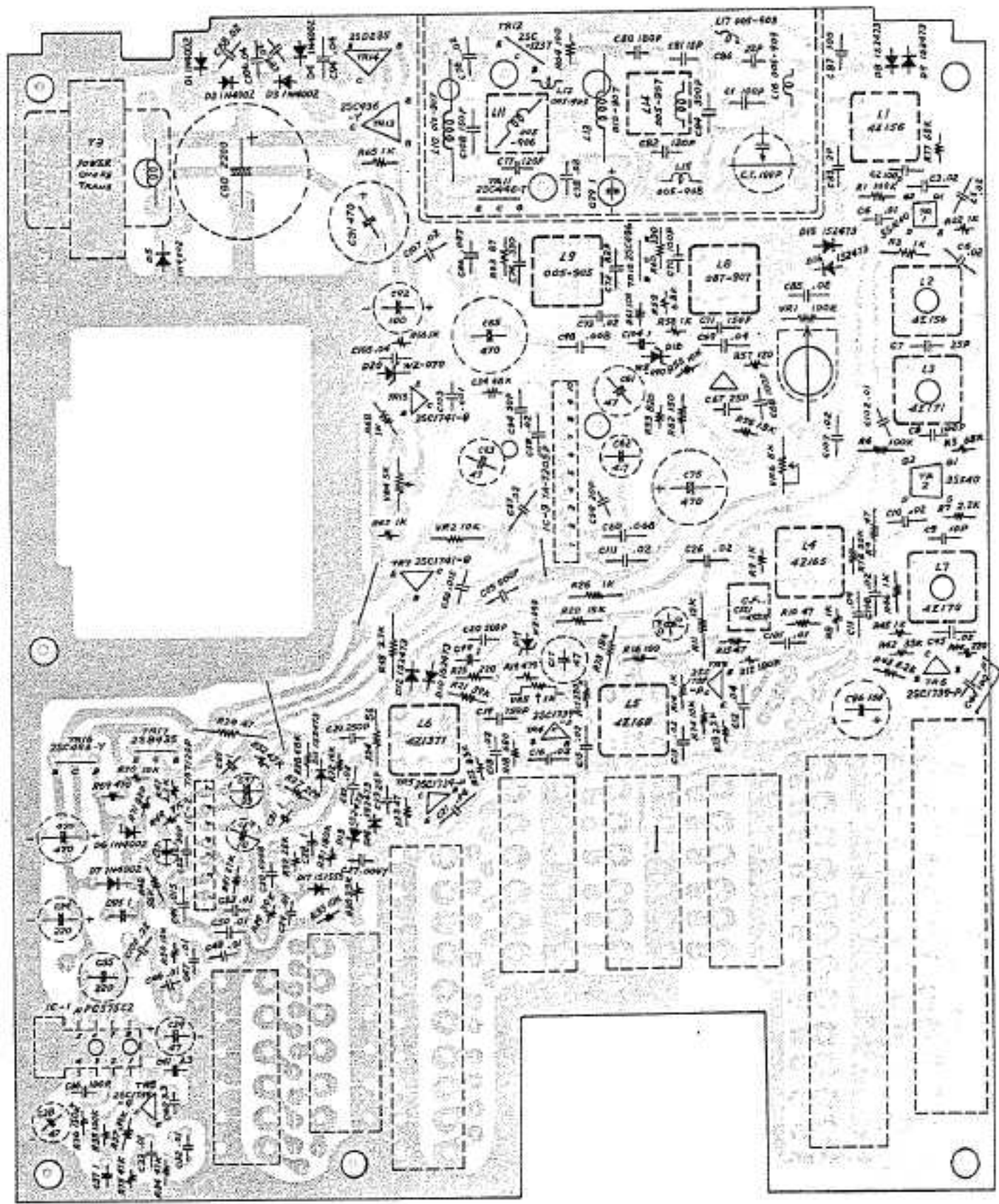

# WIRING LAYOUT

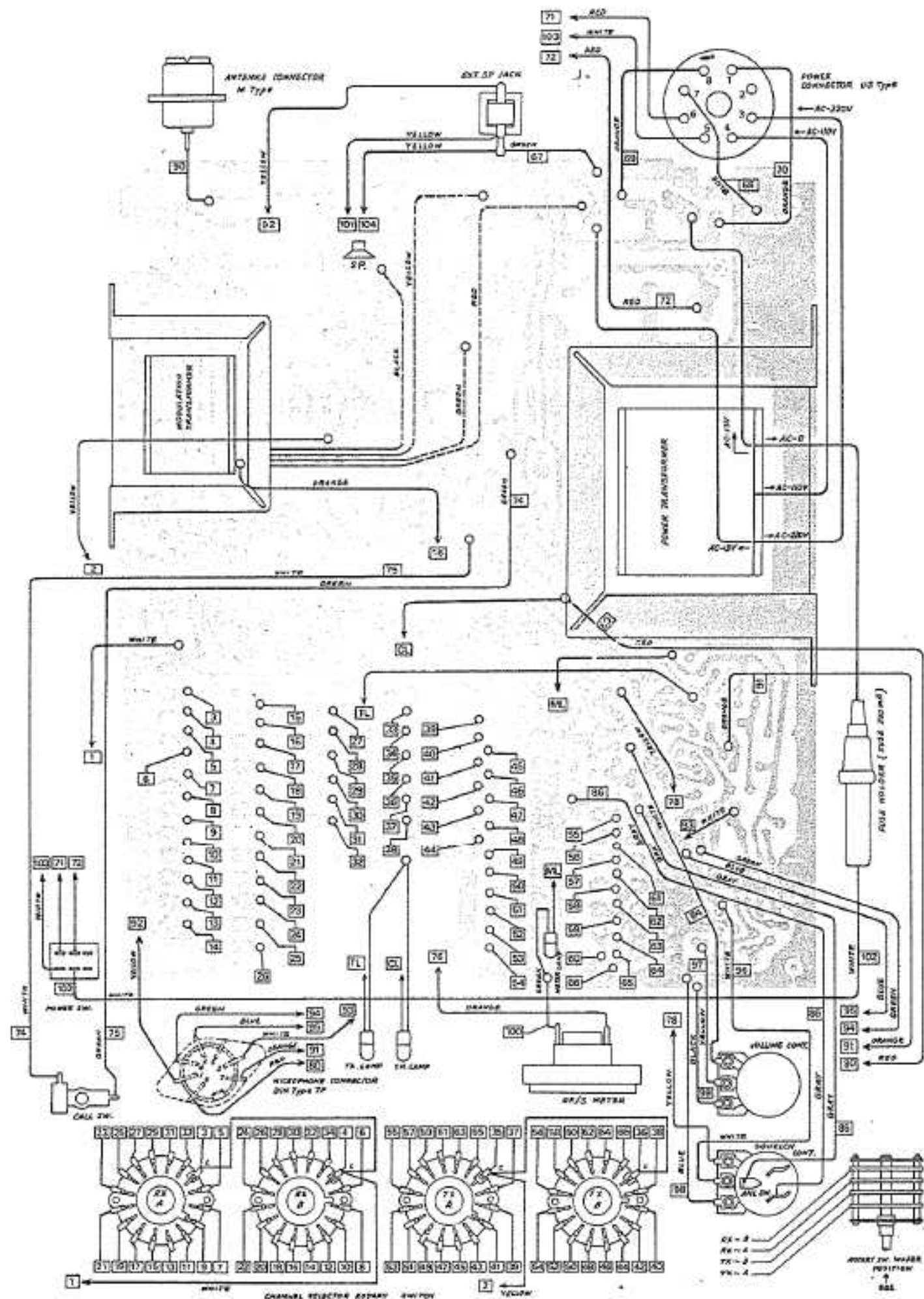

BLOCK DIAGRAM

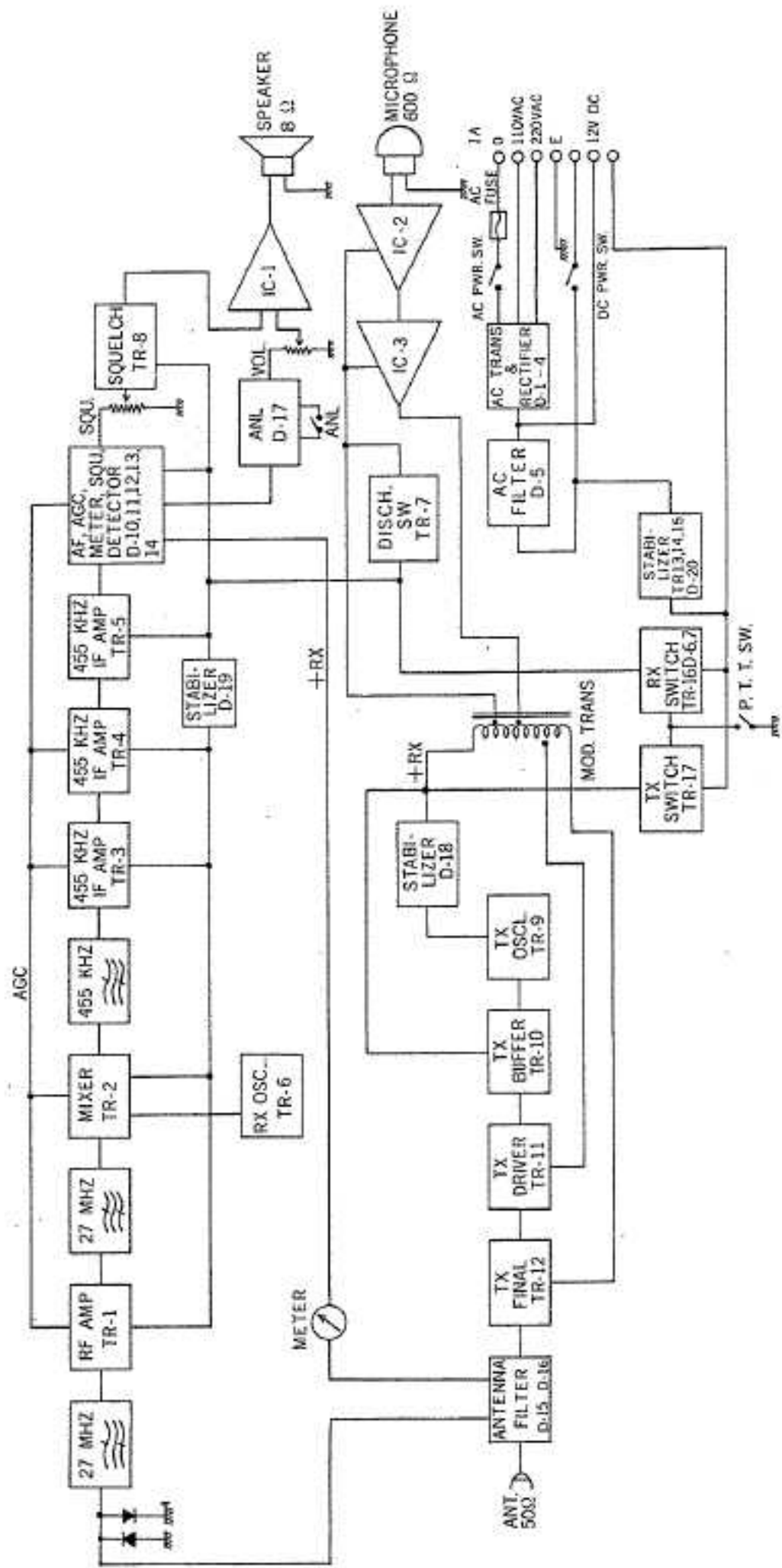

## PARTS LIST for TS-732P

DESIGNATION	PARTS NAME	PARTS NO.
MP-301	Front Frame	483014-732
MP-302	Chassis Frame	482009-732
MP-105	Cabinet Cover (Upper)	483016
MP-150	Cabinet Cover (Lower)	493040
MP-107	Mounting Bracket	484085
MP-303	Front plate (L)	494187-L
MP-350	Front plate (R)	494258
MP-351	Brand plate	494257
MP-352	Back plate	494253
MP-110	Mounting Bracket for Meter	484064
MP-208	Mounting Bracket for Transformer	484080
MP-353	Heatsink for 2SC123T (A)	494251
MP-354	Heatsink for 2SC1237 (B)	494252
MP-211	Meter Lamp Reflection plate	484063
MP-212	Channel Indicator Screen	484107
MP-214	Mounting Bracket for Channel Lamp	484108
MP-111	Call Switch Contact	484086
MP-112	Call switch Spring	484087
MP-117	Knob for Channel Selector	484116
MP-17	Knob for Vol./Squ. Control	474011
MP-118	Nut for Channel Selector	484073
MP-120	Screw for Mounting Bracket	484098
MP-355	Channel Indicator plate	484115
MP-309	Heatsink for TA7205P	494254
MP-356	Heatsink for 2SC495	494250
MP-357	Model No. Indication plate	494256
MP-20	Lamp Lens (Red)	M40024R
J1	EXT. SP. Jack	SJ-296
J2	Antenna Jack	MRM/INCH
J3	Microphone Jack DIN type /P	CS2/9
J4	Power Connector US Type	S-10507 #1
EP-501	DC Power Cord with US Type Plug & Fuse holder	W-732DC
EP-502	AC Power Cord	W-732AC
F1	Fuse 3A	F-3A
M	Meter	D33B35R
SP	Speaker	SP-70-8
PL	Pilot Lamp 14V-80mA	PL-14-80
SW1	Channel Selector Rotary Switch	S32C4232
SW2	Power Toggle Switch	8A-2011
MIC	Microphone	12-31019
EP-503	Crystal Socket 12P	XS-12P
EP-504	Crystal Socket 10P	XS-10P
EP-505	Crystal Socket 6P	XS-6P
IC-1	Integrated Circuit	$\mu$ PC5T5C2

## PARTS LIST for TS-732P

DESIGNATION	PARTS NAME	PARTS NO.
IC-2	Integrated Circuit	TA7120P
IC-3	Integrated Circuit	TA7205P
TR1,2	FET	3SK40
TR3,4,5,6,9	Transistor	2SC1739-P
TR8	Transistor	2SC1739-Q
TR13,16	Transistor	2SC496-Y
TR10	Transistor	2SC496-O
TR12	Transistor	2SC1237
TR7,15	Transistor	2SC1741-Q
TR17	Transistor	2SB435
TR14	Transistor	2SD235
TR11	Transistor	2SC495-T
D8~16	Silicon Diode	1S2473
D1~7	Silicon Diode	1N4002
D18,19	Zener Diode	WZ090
D20	Zener Diode	WZ070
L1	RX Antenna Coil	4Z156
L2	RX RF Tuning Coil (27 MHZ)	4Z156
L3	RX Mixer Coil (27 MHZ)	4Z171
L4	RX Mixer Coil (455 KHZ)	4Z165
L5	I. F. T. (455 KHZ)	4Z168
L6	I. F. T. (455 KHZ)	4Z1371
L7	RX Local osc Coil	4Z170
L8	TX OSC Coil	087-907
L9	TX Driver Tuning Coil	005-905
L10,13	RFC ( $\pi$ Match circuit)	010-907
L11	TX Power Drive Tuning Coil	005-906
L12	RFC (Power Driver)	005-903
L14	TX Power Tuning Coil	005-907
L15	TX $\pi$ Match Coil	005-908
L16	TX $\pi$ Match Antenna Loading Coil	005-909
L17	TX 54 MHZ Trap Coil	005-901
T1	Power Transformer	E1-5702
T2	Modulation Transformer	E1-4501
T3	Power Choke Transformer	E1-2501
CF	Ceramic Filter	CFU-455H
EP-506	P. C. Board	73201
VR1	Semi Variable Resistor 100K ohm	SVR100K-3H
VR2	Semi Variable Resistor 10K ohm	SVR010K-3K
VR4	Semi Variable Resistor 5K ohm	SVR005K-3V
VR6	Semi Variable Resistor 5K ohm	SVR005K-2V
VR5	Semi Variable Resistor 1K ohm	SVR001K-2V
VR7	Variable Resistor (Squelch) 10K ohm B	VR1610KBS
VR8	Variable Resistor (Volume) 50K ohm B	VR1650KB

## SPECIFICATIONS for TS-732

Semiconductors :	2 FET, 15 transistor, 20 diode.
Transmitter System:	Crystal controlled. Collector modulation AM.
Frequency :	32 channels on 27 MHz.
Input Power :	10 watts.
Band Width:	8 KHz (max).
Antenna Impedance:	50-52 ohms.
Receiver System:	Single conversion superheterodyne crystal controlled.
Sensitivity:	1 $\mu$ V or better for 100mW output, 10dB signal to noise ratio.
Intermediate Frequency:	455 KHz
Receiver Selectivity:	25 dB dc . at 10 KHz.
Squelch Sensitivity:	2 $\mu$ V
Audio Output Power:	2 watts in 10 % distortion.
Power Source:	11~16.volt D. C. Negative Ground.
Fuse :	DC: 3A
Microphone :	Dynamic type Impedance 500 ohm with press-talk switch.
Speaker:	Dynamic type voice coil impedance 8 ohm.
Size :	156X58X205 mm
Weight:	2.3 kg
Accessories:	Mounting bracket, Mounting hardware DC power cord, Microphon hanger.

## SOMMERKAMP ELECTRONIC SAS

CH-6903 LUGANO, P.O. BOX 176  
SWITZERLAND  
TEL.91 688543 TELEX:79314